

DIEBOLT

D 24 - 95 DT

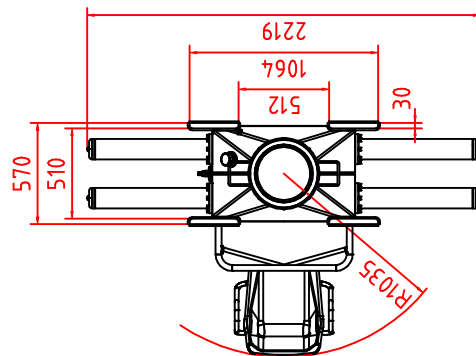
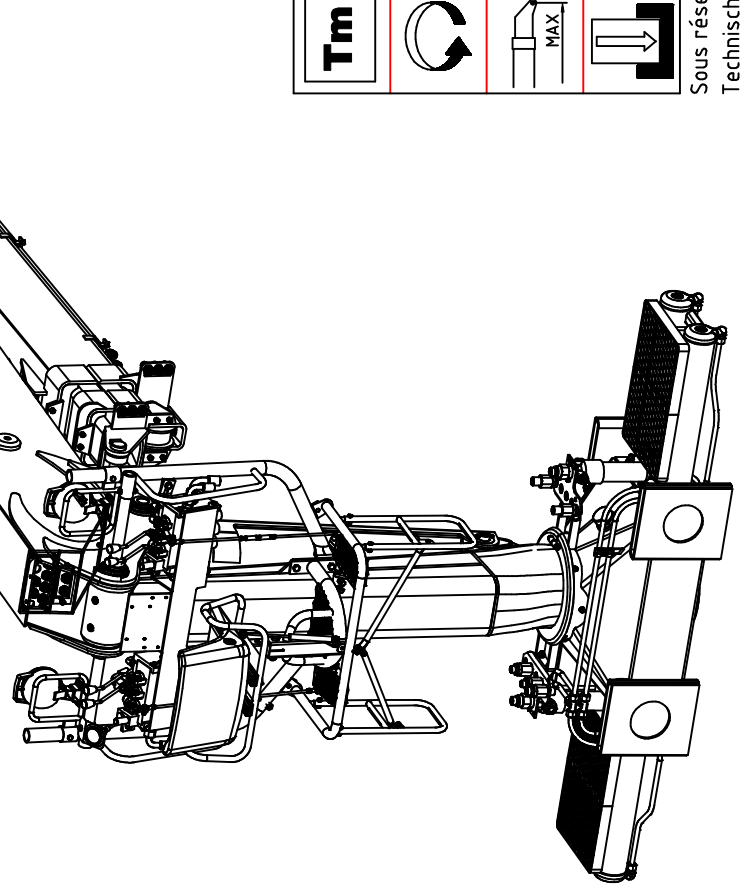
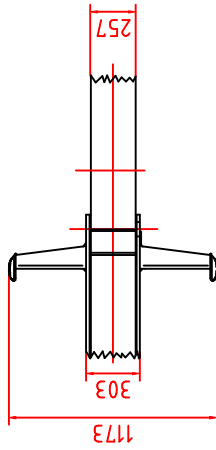
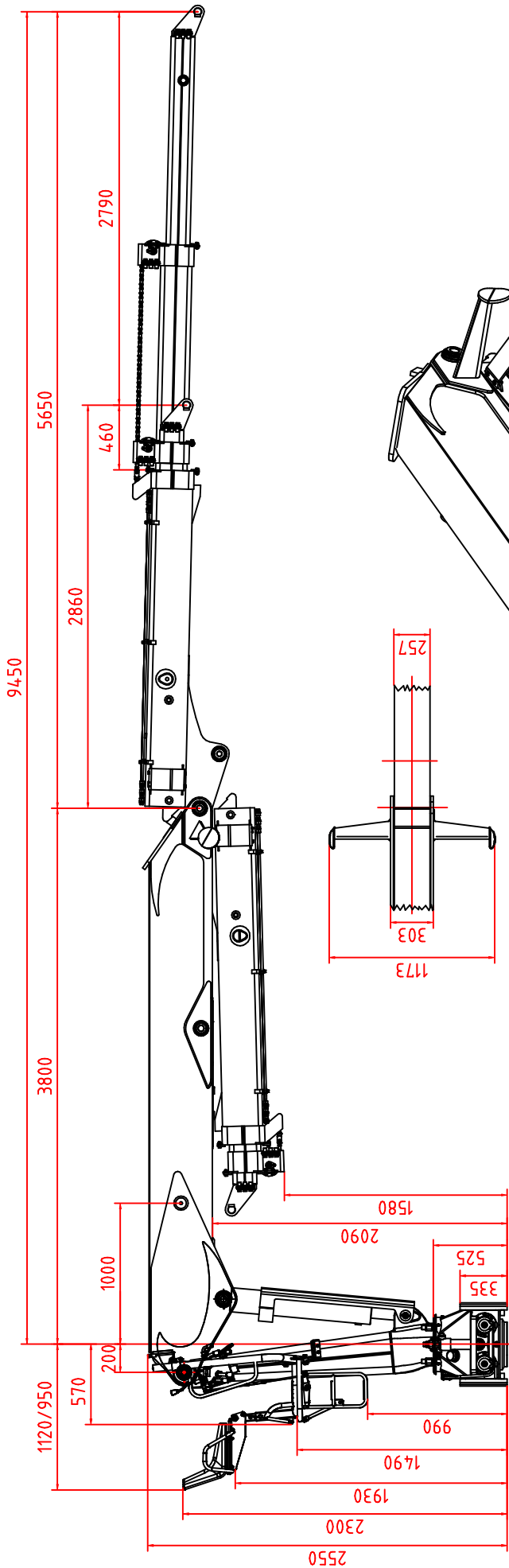

Tm	210 KNm	405°	9450 mm	250 MPa
Q	2x80 L/min	40 KNm	2790 mm	2500 Kg

Sous réserve de modifications techniques !
Technische Änderungen vorbehalten !
Technical modifications reserved !